

Overview

EKPC-D Solar PV String Level Monitoring Device monitors current and voltage at the string level inside a combiner box. This device is compatible with PV string voltages up to 1500VDC. It can monitor 8, 12, 16, 20, and 24 strings and measure up to 20A per string.

The EKPC-D Solar PV String Level Monitoring Device can be directly powered by the solar array while providing reliable information and data. It adopts an RS485 interface and supports the MODBUS protocol.

Technical Data

Model	EKPC-D8	EKPC-D12	EKPC-D16	EKPC-D20	EKPC-D24
Input channels	8	12	16	20	24
DC operating voltage	DC50V~DC1500V				
PV string current input	0~20A				
Accuracy	1%				
Response time	1S				
Temperature measuring range	-40°C~+80°C				
Temperature coefficient	250PPM/°C				
Auxiliary power input voltage	DC5V±5%				
Industrial frequency withstand voltage	2.5kV				
Communicate interface	RS485/ModBus-RTU protocol				
Baud rate	1200、2400、4800、9600、19200、38400、57600、115200bps				
Communication medium	1.5mm ² screen twisted pair, communication distance 1000 meters, maximum 128 nodes per loop				
Power consumption	<5W				
Operating temperature	-30°C~+70°C				
Storage temperature	-40°C~+80°C				
Relative humidity	0%~95%				
Altitude	≤3000m				
Insulation resistance	≥100MΩ				
Protection degree	IP30				
Dimensions(D×W×H)	210×30×67.3mm	274×30×67.3mm	346×30×67.3mm	418×30×67.3mm	490×30×67.3mm

Wiring Diagram

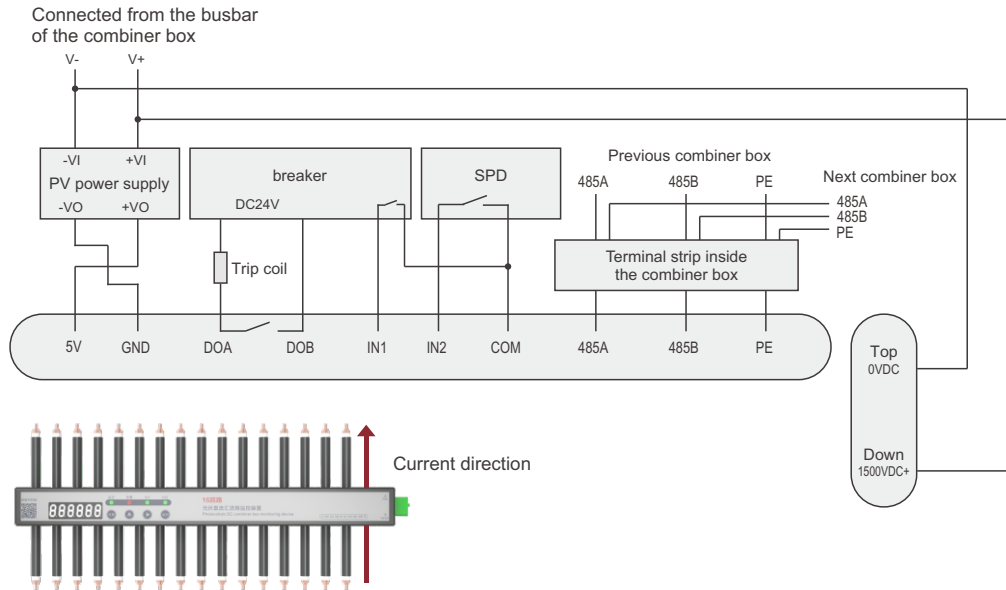

Networking Diagram

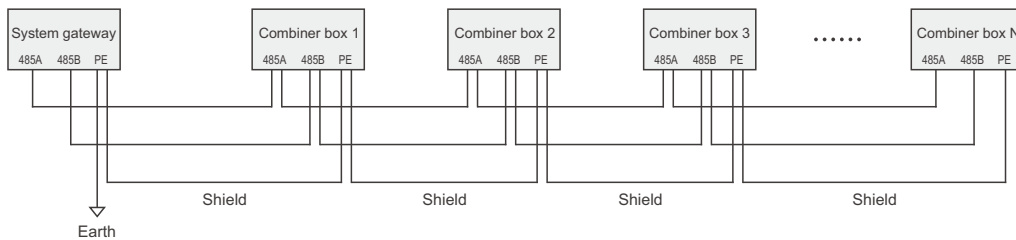

Dimensions (mm)

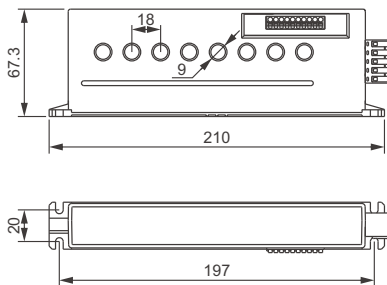

EKPC-D8

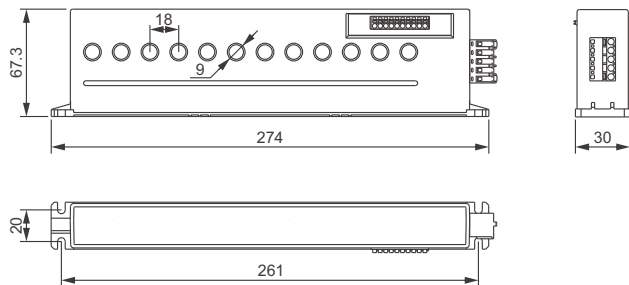

EKPC-D12

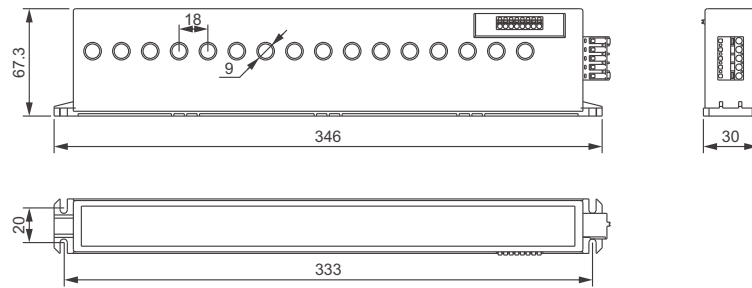

EKPC-D16

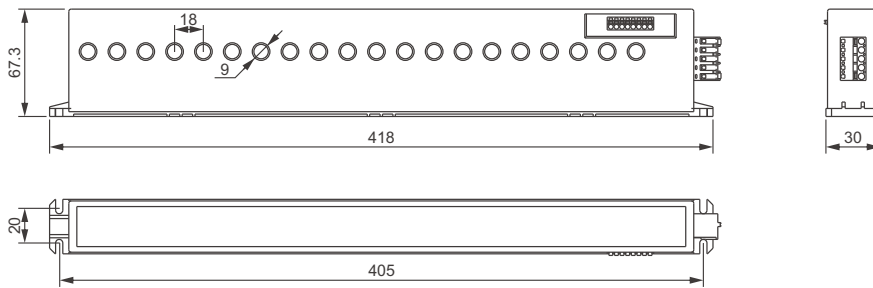

EKPC-D20

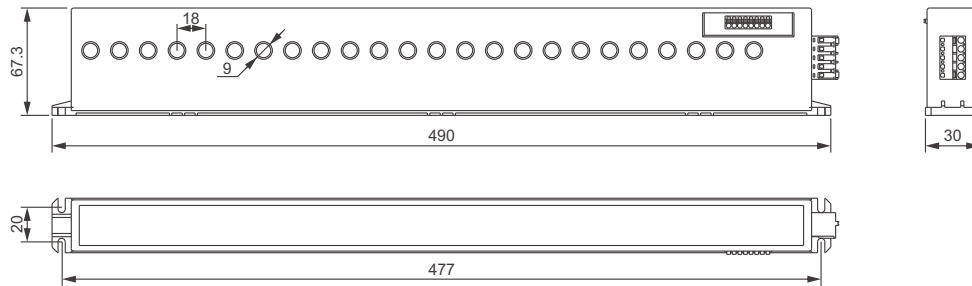

EKPC-D24

PWR-DC1500

Auxiliary Power Supply for Solar PV String Monitoring Device



Overview

PWR-DC1500 Auxiliary power supply for solar PV string monitoring device is a power supply device specially used in solar photovoltaic systems. It is used to provide reliable power supply for photovoltaic string monitoring equipment to ensure the normal operation of the monitoring system.

Technical Data

Model	PWR-DC1500
Rated operating voltage	210VDC~1800VDC
Power	5W
Power derating	4%/°C (above 70°C)
Output voltage and current	5V/1A
Ripple noise	≤100mVp-p
Maximum working efficiency	85%
Power-off time	20ms(TYP)/at Vin:1000VDC
Start-up delay time	500ms(TYP)/at Vin:1000VDC
Dynamic response	25% nominal load jump ±4%/500us
Insulation voltage	2000VDC (2000VAC)
Insulation resistance	≥100MΩ
Leakage current	0.03mA RMS TYP.1200VDC
Safety level	Class I
MTBF	>215000h @25°C
Operating temperature	-40°C~+70°C
Storage temperature	-40°C~+105°C

Dimensions (mm)

